

# STI EMERGENCY LIGHT DAMAGE STOPPERS®

## Helps Protect Operation of Emergency Lights From Theft and Vandalism

Here is an excellent way to protect your emergency lights against both vandalism and accidental damage. Some of the newest members of the STI Wire Guard Team, these Stoppers were created in response to multiple requests from STI customers. They are easy to install with all screws and anchors provided.

## Backed By a Lifetime Guarantee

Constructed of tough steel wire that is coated with corrosion resistant polyester. It is not surprising STI backs them with a lifetime guarantee against breakage in normal use. These Stoppers are highly recommended for areas where abuse is severe or it is imperative that emergency lights continue to operate.

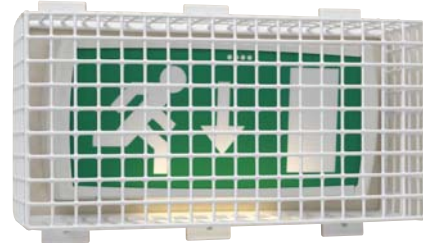

STI-9644



STI-9649

### Features

- Offers protection against vandalism and accidental damage for emergency lights.
- Constructed of tough steel wire.
- Installation is fast and simple with screws and anchors provided.
- Part of a complete line of wire guard units.
- Coated with corrosion resistant polyester.
- Lifetime guarantee against breakage in normal use.



## Safety Technology International, Inc.

2306 Airport Road • Waterford, Michigan 48327-1209

Phone: 248-673-9898 • Fax: 248-673-1246 • Toll Free: 800-888-4784 • E-mail: [info@sti-usa.com](mailto:info@sti-usa.com) • Web: [www.sti-usa.com](http://www.sti-usa.com)

Europe Branch Office • Unit 49G Pipers Road • Park Farm Industrial Estate • Redditch • Worcestershire • B98 0HU • England

Tel: 44 (0) 1527 520 999 • Fax: 44 (0) 1527 501 999 • Freephone: 0800 085 1678 (UK only) • E-mail: [info@sti-europe.com](mailto:info@sti-europe.com) • Web: [www.sti-europe.com](http://www.sti-europe.com)

# STI EMERGENCY LIGHT DAMAGE STOPPERS®

Dimensions and Technical Information

## Models Available

- STI-9641** Emergency Lighting Cage
- STI-9644** Emergency Lighting Cage
- STI-9645** Emergency Lighting Cage
- STI-9649** Emergency Light Damage Stopper

## Notice

Guard may reduce projected light values. Verify correct emergency light requirements when using guard (NFPA 101).

## Related Models Available

- Steel Web Stoppers® for smoke detectors (STI-9601 series)
- Clock/Bell Damage Stopper® (STI-9631, STI-9632, STI-9633)
- Motion Detector Damage Stopper® (STI-9618, STI-9619, STI-9620, STI-9621, STI-9622)
- Smoke Beam Guard (STI-9623, STI-9625)
- Fluorescent Light Damage Stopper® (STI-9651)
- Bay Light Damage Stopper® (STI-9702)
- Outdoor Light Damage Stopper® (STI-9703)

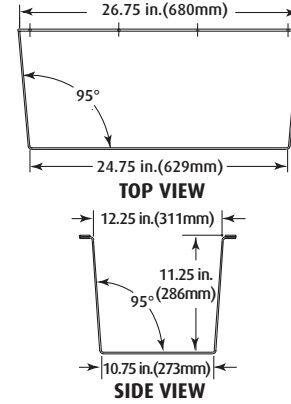

**STI-9649**

PART #	HEIGHT	WIDTH	DEPTH
STI-9641	10.7 (271)	14.6 (370)	4 (101)
STI-9644	8.7 (220)	17.75 (450)	5.25 (133)
STI-9645	13.75 (349)	21.6 (548)	5.9 (149)
STI-9649	10.75 (273)	24.75 (629)	11.25 (286)

**NOTE:** Dimensions measure: inches (mm)

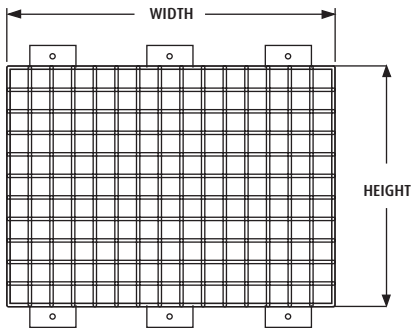
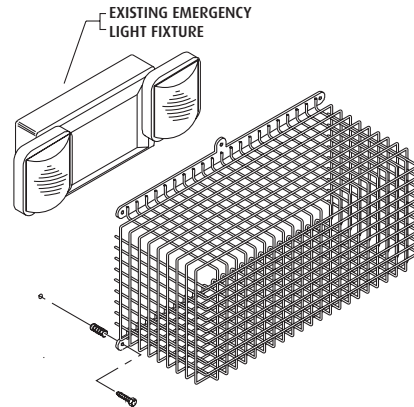

**STI 9641 & STI 9645  
 TOP VIEW**

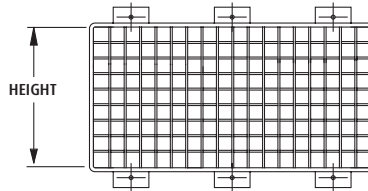

**STI-9644  
 TOP VIEW**

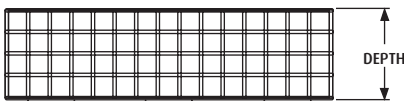

**STI 9641 & STI 9645  
 SIDE VIEW**

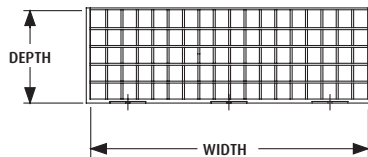

**STI-9644  
 SIDE VIEW**