

Larsen's®

Gemini Series Fire Extinguisher Cabinets Submittal and Detail Sheet

PROJECT: _____
 MODEL NUMBER: _____
 ARCHITECT: _____
 DATE: _____

LOCATION: _____
 QUANTITY: _____
 CONTRACTOR: _____
 DISTRIBUTOR: **Hallmann Sales**

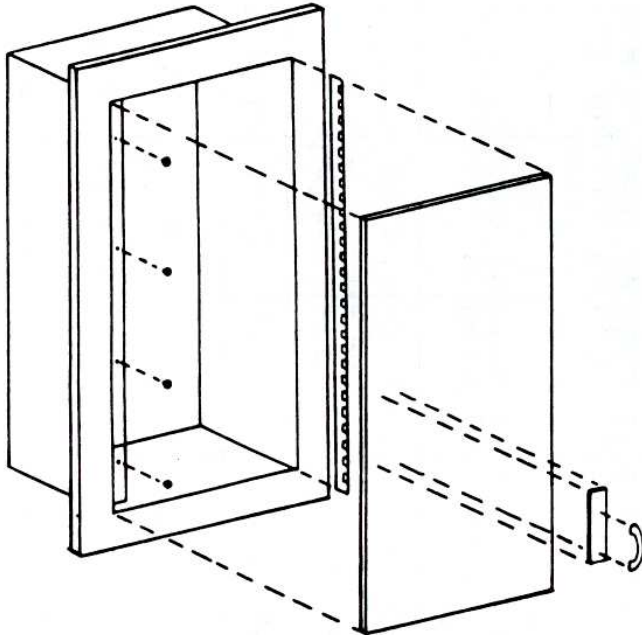

SPECIFICATIONS:

"GEMINI" donates a frameless acrylic door, with color and design options as outlined below. The door is constructed of 1/4" thick smooth or textured acrylic. If lettering is specified, the design is placed on the back side of door to prevent damage. The Larsen-Loc® is available with all door styles. All doors have a satin finish pull handle with a self-adjusting roller catch; and continuous piano hinge constructed of material, which matches the trim.

BOX SPECIFICATION:

All recessed and semi-recessed cabinets and surface-mounted steel cabinets have a heavy gauge, white baked enamel box. Surface-mounted cabinets with aluminum trim have a box constructed entirely of clear or color anodized aluminum. Surface-mounted cabinets with stainless steel door and trim have a box constructed entirely of 304 stainless steel with a #4 finish.

TRIM SPECIFICATION:

Steel trims are one piece, constructed of heavy gauge, cold-rolled steel with a standard finish of white baked enamel, which can be used as either a finish or prime coat. Aluminum trims are constructed of extruded aluminum with satin anodized finish. Clear anodized is standard, and a wide selection of optional color anodized finishes is available. All trim corners are mitered. To specify aluminum trim, use the prefix "AL" before the cabinet model number. Stainless steel trims are one piece, constructed of heavy gauge, #4 finish, 304 stainless steel. To specify stainless steel trim, use the prefix "SS" before the cabinet model number.

TRIM PROJECTION

- Flat - 5/16"
- 1 1/4" or 1 1/2" Square
- 2 1/2" Rolled Edge
- 3 1/2" Rolled Edge
- 4" Rolled Edge
- 4 1/2" Rolled Edge
- Trimless†
- Surface Mounted

TRIM MATERIALS

- Steel
- Aluminum (AL)
- Stainless (SS)
- Other (Specify)

RECESSED HANDLE (Required only for 4" return trims when ADA wall projection compliance is necessary.)

(SEE BACK OF THIS SHEET OR ATTACHED SHEET FOR DIMENSIONS & DOOR STYLES)

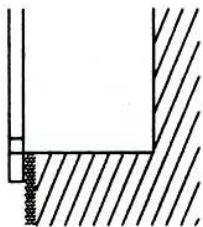

5/16" Flat Trim
Fully Recessed

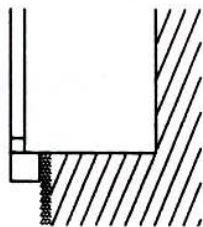

1 1/4" or 1 1/2"
Square Trim
Semi-Recessed

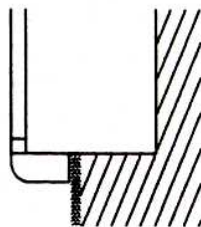

2 1/2", 3 1/2", 4", or 4 1/2"
Rolled Edge
Semi-Recessed

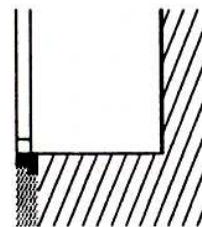

3/4" Plaster Stop
Trimless †

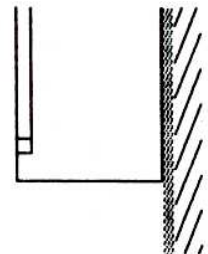

Surface
Mounted

† Trimless cabinets must be installed before the drywall because their plaster stops must be behind the drywall. Trimless cabinets are not recommended for block wall installation.

LARSEN'S MANUFACTURING COMPANY - www.larsensmfg.com

7421 Commerce Lane N.E., Minneapolis, MN 55432 Phone: (763) 571-1181 FAX: (763) 571-6900

FLORIDA DIVISION: 3130 N.W. 17th Street, Ft. Lauderdale, FL 33311 Phone: (954) 486-3325 FAX: (954) 486-3352

CABINET DIMENSIONS - GEMINI SERIES

Model Number	Trim Style and Projection	Inside Box Dimensions			Outside Trim Dimensions**		Rough Opening***			Recommended Extinguisher Capacity
		Height	Width	Depth	Height	Width	Height	Width	Depth	
G 2409-R1	Rec. 5/16"	24"	9½"	5"	27½"	13"	25"	10½"	5½"	MP 2-1/2,MP5, MP5-A,DC2-1/2, DC5,HT2-1/2,HT5
G 2409-5R	Semi-Rec. 1½"	24"	9½"	5"	27½"	13"	25"	10½"	4"	
G 2409-R3	Semi-Rec. 2½"	24"	9½"	5"	27½"	13"	25"	10½"	3"	
G 2409-R2	Rec. 5/16"	24"	9½"	6"	27½"	13"	25"	10½"	6¼"	MP 2-1/2,MP5, MP5-A,DC2-1/2,DC5 MP6,MP10 DC6,DC10,CD5 HT2-1/2,HT5
G 2409-R7	Semi-Rec. 1½"	24"	9½"	6"	27½"	13"	25"	10½"	5"	
G 2409-6R	Semi-Rec. 2½"	24"	9½"	6"	27½"	13"	25"	10½"	4"	
G 2409-RM	Semi-Rec. 4½"	24"	9½"	6"	27½"	13"	25"	10½"	2"	
G 2409-RT	Trimless	24"	9½"	6"	-	-	†	†	6½"	
G 2409-R4	Semi-Rec. 3½"	24"	9½"	6"	27½"	13"	25"	10½"	3"	
G 2409-SM	Surface Mounted	27½"	13"	6"	27½"	13"	-	-	-	
G 2409-RA	Semi-Rec. 4"	24"	9½"	6"	27½"	13"	25"	10½"	2½"	

* Depth of these cabinets is 4-3/4" when supplied with aluminum door and frame. The ALG2409-5R has a 1-1/4" square trim.

G 2712-R	Rec. 5/16"	27"	12"	8"	30½"	15½"	28"	13"	8¼"	All of Above, PW 2-1/2,MP20, DC20,CD10 WC-6L, HT11, HT15-1/2
G 2712-RK	Semi-Rec. 1¼"	27"	12"	8"	30½"	15½"	28"	13"	7¼"	
G 2712-RL	Semi-Rec. 2½"	27"	12"	8"	30½"	15½"	28"	13"	6"	
G 2712-RM	Semi-Rec. 4½"	27"	12"	8"	30½"	15½"	28"	13"	4"	
G 2712-RT	Trimless	27"	12"	8"	-	†	†	†	8½"	
G 2712-SM	Surface Mounted	30½"	15½"	8½"	30½"	15½"	-	-	-	
G 2712-RA	Semi-Rec. 4"	27"	12"	8"	30½"	15½"	28"	13"	4½"	
G 2720-R	Rec. 5/16"	27"	20"	8"	30½"	23½"	28"	21"	8¼"	Two Each of the Listed: PW2-1/2,MP10, DC10,MP20, DC20,CD5, CD10,WC-6L, HT11, HT15-1/2
G 2720-RK	Semi-Rec. 1¼"	27"	20"	8"	30½"	23½"	28"	21"	7¼"	
G 2720-RL	Semi-Rec. 2½"	27"	20"	8"	30½"	23½"	28"	21"	6"	
G 2720-RM	Semi-Rec. 4½"	27"	20"	8"	30½"	23½"	28"	21"	4"	
G 2720-RT	Trimless	27"	20"	8"	-	-	†	†	8½"	
G 2720-SM	Surface Mounted	30½"	23½"	8½"	30½"	23½"	-	-	-	
G 2720-RA	Semi-Rec. 4"	27"	20"	8"	30½"	23½"	28"	21"	4½"	
G 3012-R	Rec. 5/16"	30"	12"	8"	33½"	15½"	31"	13"	8¼"	Same as G2712
G 3012-RK	Semi-Rec. 1¼"	30"	12"	8"	33½"	15½"	31"	13"	7¼"	
G 3012-RL	Semi-Rec. 2½"	30"	12"	8"	33½"	15½"	31"	13"	6"	
G 3012-RM	Semi-Rec. 4½"	30"	12"	8"	33½"	15½"	31"	13"	4"	
G 3012-RT	Trimless	30"	12"	8"	-	-	†	†	8½"	
G 3012-SM	Surface Mounted	33½"	15½"	8½"	33½"	15½"	-	-	-	
G 3012-RA	Semi-Rec. 4"	30"	12"	8"	33½"	15½"	31"	13"	4-1/2"	
G 3612-R	Rec. 5/16"	36"	12"	8"	39½"	15½"	37"	13"	8¼"	Same as G2712
G 3612-RK	Semi-Rec. 1¼"	36"	12"	8"	39½"	15½"	37"	13"	7¼"	
G 3612-RL	Semi-Rec. 2½"	36"	12"	8"	39½"	15½"	37"	13"	6"	
G 3612-RM	Semi-Rec. 4½"	36"	12"	8"	39½"	15½"	37"	13"	4"	
G 3612-RT	Trimless	36"	12"	8"	-	-	†	†	8½"	
G 3612-SM	Surface Mounted	39½"	15½"	8½"	39½"	15½"	-	-	-	
G 3612-RA	Semi-Rec. 4"	36"	12"	8"	39½"	15½"	37"	13"	4½"	
GM 3216-R	Rec. 5/16"	32"	16"	8"	35½"	19½"	33"	17"	8¼"	PW2-1/2,MP20, DC20,CD10, CD15 WM 2-1/2
GM 3216-RK	Semi-Rec. 1¼"	32"	16"	8"	35½"	19½"	33"	17"	7¼"	
GM 3216-RL	Semi-Rec. 2½"	32"	16"	8"	35½"	19½"	33"	17"	6"	
GM 3216-RM	Semi-Rec. 4½"	32"	16"	8"	35½"	19½"	33"	17"	4"	
GM 3216-RT	Trimless	32"	16"	8"	-	-	†	†	8½"	
GM 3216-SM	Surface Mounted	35½"	19½"	8½"	35½"	19½"	-	-	-	
GM 3216-RA	Semi-Rec. 4"	32"	16"	8"	35½"	19½"	33"	17"	4½"	

† Trimless cabinets must be installed before the drywall because their plaster stops must be behind the drywall.

Trimless cabinets are not recommended for block wall installation.

** Deduct 3/4" from HxW dimensions for cabinets with aluminum trim.

*** Rough openings are larger for fire-rated cabinets. Please refer to Fire-rated Extinguisher Cabinet Submittal and Detail Sheet.

NOTE: Semi-recessed and surface-mounted cabinet compliance with ADA wall projection guidelines depends on several location and installation issues.

Please refer to <http://www.larsensmfg.com/>

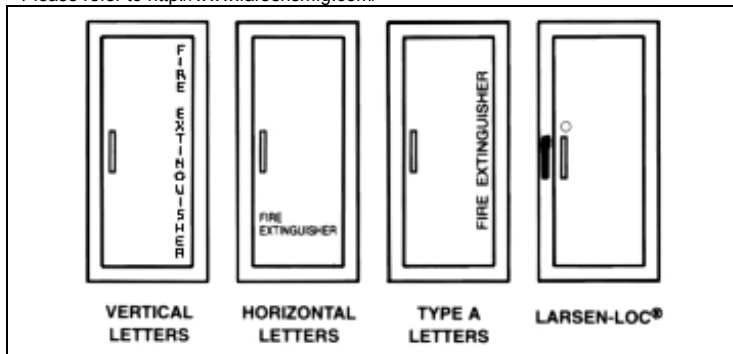

- | | |
|---|--|
| <p>DOOR DESIGN</p> <ul style="list-style-type: none"> <input type="checkbox"/> Vertical Letters <input type="checkbox"/> Horizontal Letters <input type="checkbox"/> Type A Letters <input type="checkbox"/> Clear - No Letters <input type="checkbox"/> Bronze - No Letters <input type="checkbox"/> Larsen-Loc® (Available with all door styles) | <p>DOOR & LETTERING COLORS</p> <ul style="list-style-type: none"> <input type="checkbox"/> Clear - No Letters <input type="checkbox"/> Clear - Red Letters <input type="checkbox"/> Clear - White Letters <input type="checkbox"/> Clear - Black Letters <input type="checkbox"/> White - Black Letters <input type="checkbox"/> White - Red Letters <input type="checkbox"/> Black - White Letters <input type="checkbox"/> Red - White Letters <input type="checkbox"/> Bronze - White Letters |
|---|--|

LARSEN'S MANUFACTURING COMPANY - www.larsensmfg.com

7421 Commerce Lane N.E., Mpls, MN 55432 Phone: (763) 571-1181 FAX: (763) 571-6900

FLORIDA DIVISION: 3130 N.W. 17th Street, Ft. Lauderdale, FL 33311 Phone: (954) 486-3325 FAX: (954) 486-3352

www.Hallmann-Sales.com